

MODENA+

- ✓ Robust
- ✓ Sleek lines
- ✓ Progressive traction lever for optimum effort control
- ✓ Silent
- ✓ Good ergonomics

Up to 200 loaves an hour

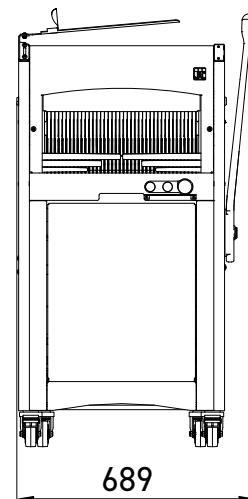

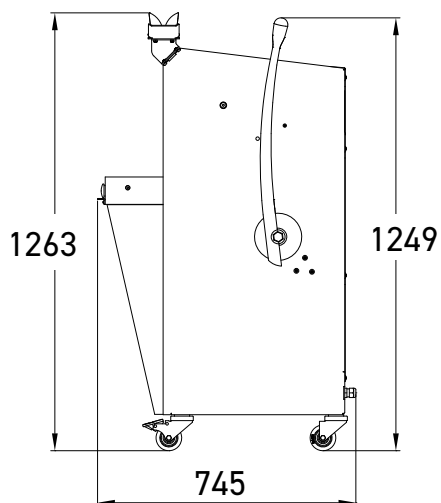

Progressive traction lever
Controls effort more effectively.



Removable crumb collector
Accessible by tilting the front, cylinder-assisted door. 18 litre capacity.



JAC FLAPS
Holds the loaf together for easier handling at the exit of the machine.

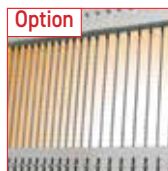

Option

Double slice thickness
Allows two different slicing widths on the same machine



Option

Daily adding counter
Tells the user how many loaves have been cut for maintenance interval monitoring purposes.



Option

4cm height adjustment
Increases working comfort for tall operators.



Type available
"M" system

Micronised knife lubrication system for cutting bread with a high rye content or sticky crumb. Developed by JAC, it consumes the least possible amount of oil (120 ml per 1000 loaves) and produces a consistent cutting quality.

FEATURES	MODENA+ 450	MODENA+ 450M 
Max. loaf dimensions in cm (L x W x H)	44 x 30 x 16	44 x 29 x 16
Motor power in kW	0.49	1.5
Net weight (in kg)	165	175
Blade type and dimensions in mm	13 x 0.5 steel	13 x 0.5 Teflon coated
Daily adding counter		•

CHOICES	MODENA+ 450	MODENA+ 450M 
Slice thickness in mm	9 - 18	9 - 12
Loaf pusher height	Extra low (50mm) Low (80mm) High (100m)	Misch (80mm)
Power supply	230V single phase 230V three-phase 400V three-phase	400V three-phase
Standard colour*	•	•

OPTIONS	MODENA+ 450	MODENA+ 450M 
Heavy duty motor	•	Standard
4cm height adjustment	•	•
Double slice thickness	•	n/a
Daily adding counter	•	Standard
Special colour	•	•
Special blades	•	Standard teflon

*STANDAARDKLEUREN



RAL 3013



RAL 9005

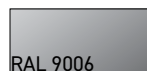

RAL 9006



RAL 9010